



**MITSUBISHI
MOTORS**

Drive your Ambition



TRITON

POWER FOR ADVENTURE



NOTHING CAN FRIGHTEN A TRITON

Since 1917 Mitsubishi Motors has been at the forefront of technological innovations. Having launched the inventive Super Select 4WD-II system and the world's first Plug-in-hybrid electric SUV, our vehicles have been tested and triumphant on some of the world's toughest terrains including the Dakar rally. These engineering milestones, together with our commitment to reliability and ingenuity sets us apart. As we continue to move forward, pushing the boundaries of innovations, you can rest assured your Mitsubishi has been built for your next adventure.



THE FREEDOM TO EXPLORE

Drive large and in charge, anywhere your sense of adventure dares take you in the all-new Mitsubishi Triton.

Feel the new, more powerful performance both on and off-road. With stronger towing muscle, and larger dimensions all-round this is a ute that isn't frightened of any challenge - from the roughest worksite to the wildest escape.

GSR model shown with standard accessories: Black Sailplane and Tub Liner.

TAKE CONTROL IN THE TOUGHEST TERRAIN



The advanced driving technology of the all-new Mitsubishi Triton will take you places you've only dreamed of. Hill Start Assist (HSA) helps prevent you rolling backwards on steep slopes by maintaining braking force on any surface, whilst Hill Descent Control (HDC)* intelligently manages your speed down steep hills for safer steering and braking control. This makes all- new Triton the perfect balance of next-generation technology and rugged Australian ute.

TOTAL CONFIDENCE FROM TOTAL CONTROL



GSR model shown with standard accessories: Black Sailplane and Tub Liner.

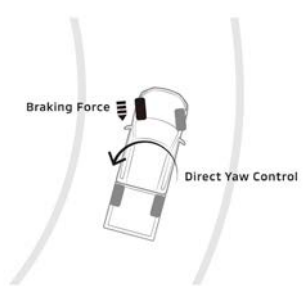

Triton lets you push the limits of action and adventure on or off-road - all whilst keeping everything under total control. All models feature Active Stability and Active Traction Control for excellent stability and traction when cornering on any surface. An active Limited Slip Differential helps prevent wheel spin on even the most treacherous off-road situations.

And if that isn't enough, Triton GSR and GLS models feature Active Yaw Control for precision handling on slippery gravel or snowy roads. It's a complete driving excitement package waiting for you.

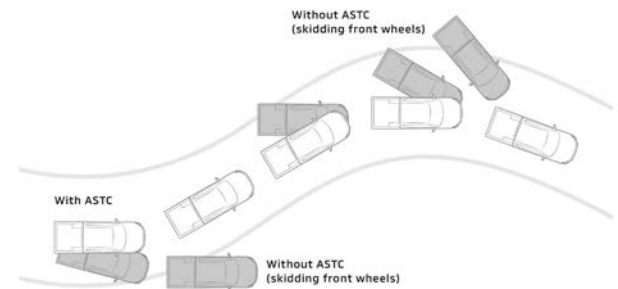

Active Yaw Control (AYC)

TOW MORE, ENJOY MORE RELAX MORE



Great towing starts with great muscle. The all-new 2.4-litre Bi-Turbo diesel engine features 'twin-stage' turbo charging for maximum grunt of 150kW power and 470Nm torque at a lower rev range than ever before. With strengthened chassis frame and suspension, Triton now has 3500 kg towing capacity. This is further enhanced with Trailer Stability Assist which helps prevent 'trailer swing' by controlling individual wheel slip to settle the trailer when it detects the trailer starting to oscillate at speed. Other road users are also alerted with flashing brake lights on both Triton and trailer.

DISCOVER ADVENTURE ON ANY ROAD

Competition-proven in punishing off-road rallies around the world, then rigorously tested and tuned in Australia, the all-new Triton will take you to the edge of the earth and safely back. The GLS and GSR Super Select 4WD-II models feature seven unique terrain modes: Normal mode, ECO mode, Gravel mode, Snow mode, Mud mode, Sand mode and Rock mode. So, no matter the driving conditions, you have the precise traction to conquer the most challenging terrain.

GSR model shown with standard accessories: Black Sailplane and Tub Liner.



Super Select 4WD-II

Triton GLS and GSR models feature Mitsubishi's proven Super Select 4WD -II system. This gives you exceptional all-terrain performance with four selectable modes, including 4H (full-time 4WD). Using the drive selector dial you can switch between 2WD (2H) and 4WD (4H, 4HLc) with shift-on-the-fly convenience at up to 100km/h.



 2H 2WD	 4H Full-time 4WD
 4HLc Centre Diff Locked 4WD	 4LLc Low Gear Centre Diff Locked 4WD



BUILT TO GO ANYWHERE



New Chassis Frame

Mitsubishi's chassis frames are rigorously tested and proven in the harshest terrains. Built with high-tensile materials, its is designed to withstand the toughest terrain and ensure reliable performance in any condition. This rigid frame is the foundation upon which Triton's outstanding on/off-road performance and ride comfort is engineered.



Redesigned Suspension System

Both front and rear suspension systems are completely redesigned for next level performance, comfort, and handling both on and off-road..



TECHNOLOGY AT YOUR FINGERTIPS



9-inch Infotainment System

Enjoy a stress-free and enjoyable time in the vehicle with the intuitive and convenient 9-inch infotainment system that comes with smartphone connectivity (Android Auto™ and wireless Apple CarPlay) and Navigation system. The new big and high-resolution screen is located high on the dash panel for easy to use convenience.

*Smartphone link Display Audio connectivity will not operate in areas with no service signal and may not operate in supported areas where the signal is weak. Users are responsible for all charges incurred using smartphones MiDisplay to Mitsubishi's Smartphone-link Display Audio.

EMPOWERS ANY JOURNEY

Triton's interior is designed to deliver a pleasurable driving experience. Ergonomically designed for long trip comfort and packed with cutting edge technology, this is an environment that is perfect for work, play or family - around the block or around the country.

Charging within reach

Stay connected with 2-USB ports (Type A and C) at the front and 2-USB power ports (Type A and C) at the back of the console so your devices can remain charged at all times.

Multi-Information Meter

The new 7-inch multi-information display features 'at a glance' recognition and clarity - giving you all the vehicle's vital data and performance information for a more engaging drive.





SPACE TO SHARE AND ENJOY

With new, ergonomically supportive seats and increased cabin space, on or off-road trips offer a level of comfort that is more car-like than utility.



GSR interior shown.

Next level air conditioning

Nothing is as important in the Australian environment than awesome air-conditioning and the all-new Triton has a powerful system to keep everyone cool even on sweltering days. It even features a rear roof mounted adjustable air circulator, so every passenger is kept in complete comfort.



THE ULTIMATE WORKHORSE THAT GETS THE JOB DONE



Double CAB

Big and practical cargo space

With enough room to fit a 1200x800mm Euro pallet, the versatile cargo bed can easily carry all your workday tools and equipment or weekend adventure essentials.



Wide Side-Step

Play it safe getting in and out with slip-resistant side-steps, even in wet or slippery conditions.

Rear Bumper Corner Shape

When loading and unloading gear when the tailgate is open, the rear bumper corner step provides the largest foot-space in the category for added ease and safety.



Large cargo area

Triton's large cargo area enables you to pack in everything you need for worksite or family adventure.

Rear Inner Hooks

Low-placed rear inner hooks are conveniently located for secure tie-down of loads.



Overseas model shown.

PEACE OF MIND WITH ADVANCED SAFETY FEATURES



Mitsubishi Motors Intuitive Technology or MITEC, is an integrated system[^] of brilliant innovations in action, working in unison to guide, protect and alert. It thinks like you, reacts like you, before you even know it. MITEC delivers reassuring safety and next generation features to give you peace of mind during every adventure and ensuring a safe return home.

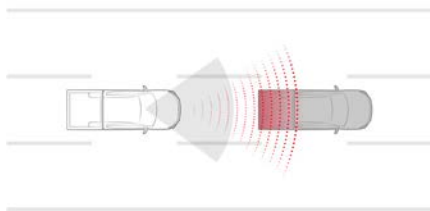

Adaptive Cruise Control (ACC)

Adaptive Cruise Control uses radar technology to detect any cars in the same lane and adjusts the speed of your car accordingly while maintaining a safe distance set by you.

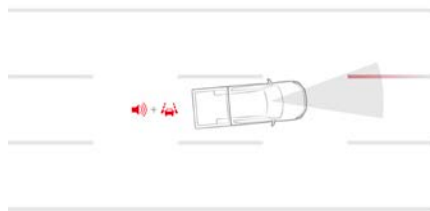

Lane Departure Warning (LDW)

Lane Departure Warning uses front camera to issue an alert if the vehicle drifts from its lane while the turn signals are not operating. The system operates at speeds above 60km/h and will vibrate the steering wheel and flash lane departure warning light.

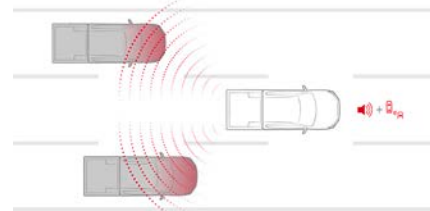

Blind Spot Warning (BSW)

Blind Spot Warning uses the rear radar sensors to detect another vehicle travelling or overtaking in the next lane behind. The system operates at speeds above 10km/h and will illuminate the BSW warning light in the corresponding side mirror when a vehicle is in the detection zone. If driver activates the turn signal towards the corresponding hazard, the BSW lamp will blink, and audible alert will sound twice.

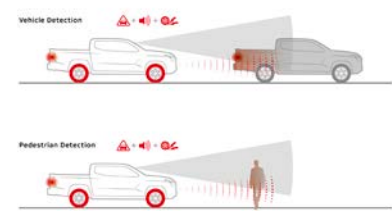

Forward Collision Mitigation (FCM)

Forward Collision Mitigation system with pedestrian detection, cyclist detection and junction assist detects obstructions ahead and issues a visual and audible alert when there is a danger of collision and automatically applies the brakes to avoid collision or reduce impact speed/severity.

Driver Attention Alert (DAA)

Driver Attention Alert (DAA) monitors the driver's steering behaviour to alert for potential driver distraction or drowsiness at speeds over 60km/h. Audible and visual warnings are signaled to the driver suggesting "take a break".

Rear Cross Traffic Alert (RCTA)

The Rear Cross Traffic Alert detects a moving object when reversing, a warning message appears on the multi-information display. The system operates when the vehicle is in reverse at speeds below 8km/h. It can detect moving objects from approx. 20m away, alerting the driver via an audible chime and blinking BSW warning light in side mirror.

Front Cross Traffic Alert (FCTA)*

Front Cross Traffic Alert system uses the front side radar sensors to detect another vehicle approaching when entering an intersection. It can detect an approaching vehicle from approx. 20m away, alerting the driver via an audible chime and blinking light in the multi-information meter*.

* No Cost Option that can be enabled by the dealership. Not compatible with Front Protection Bar (FPB) Genuine Accessory.

Intelligent Speed Limiter (ISL)

The ISL prompts the driver to reset the vehicle's upper speed limit to the newly detected speed limit. If there are no speed limit signs on the road, the speed limit data from the navigation system is used. These systems help prevent inadvertent speeding and support safe driving.

Tyre Pressure Monitor System (TPMS)

TPMS monitors tyre pressure and detects low pressure early for safe and fuel-efficient driving. It will display the current pressure of each tyre with low pressure warning if the tyre pressure is less than the user set target tyre pressure.

Hill Descent Control (HDC)

Pressing the HDC mode selector activates the HDC, which automatically maintains the driver's selected speed while traveling downhill. This lets the driver concentrate on steering for a safer driving experience without having to manually apply the brakes. HDC can be activated and set at any speed between 2 and 20km/h.

Hill Start Assist (HSA)

Steep hills and city streets are no longer a problem with Mitsubishi's Hill Start Assist technology. Hill Start Assist automatically keeps the brakes applied to help prevent the vehicle from rolling backwards, before automatically releasing the brakes in the time it takes for the driver to apply the accelerator when the vehicle is stopped on a hill.

Multi Around View Monitor

Multi Around Monitor provides a 360° birds-eye view of your Triton. The view from cameras mounted on the front, rear and sides of the vehicle (including birds-eye view) can be displayed in various combinations to reveal what is in your blind spots and help you park more safely.

Rear Automatic Emergency Braking

Rear Automatic Emergency Braking system detects obstructions behind the vehicle and warns via visual and audio alerts when there is a risk of collision. It automatically applies brakes to avoid or reduce the impact. Rear-AEB is automatically disengaged when a trailer is hitched to the Triton when using Mitsubishi Genuine towing accessories.

Traffic Sign Recognition (TSR)

The Traffic Sign Recognition (TSR) system recognises speed limit signs via a front windscreen-mounted camera or navigation system data, which is displayed on the Multi-Information Display. TSR alerts the driver with a visual alert if the vehicle exceeds the speed limit.

Automatic High Beam

Auto High Beam provides comfortable and safe night time driving. The system automatically switches the headlights between low and high beam if it detects a vehicle ahead, allowing the driver to keep both hands on the steering wheel.

Lane Departure Prevention (LDP) with Emergency Lane Assist (ELA)

Emergency Lane Assist uses the front camera to detect the road edge and lane markings, and front radar to detect vehicles approaching from the front, while simultaneously using the rear side radar sensors to detect vehicles approaching from the rear. The system operates at speeds above 60km/h and will vibrate the steering wheel and flash the lane departure warning light when activated. The vehicle will also apply the brakes on one side to help return the vehicle to the centre of the travelling lane.

Driver Monitor System (DMS)

The Driver Monitoring System uses a steering column-mounted camera to monitor the driver's face and detect a potential lack of driver attention or drowsiness. When detected, the system can respond with an audio prompt or visual alert which appears on the meter display. If the system detects distraction, the Forward Collision Mitigation (FCM) operates earlier than usual. If the system detects fatigue (Drowsiness, Micro-sleep, Sleep), FCM and Lane Departure Warning operate earlier than usual.

Blind Spot Warning & Lane Change Assist

Blind spot Warning uses the rear side radar sensors to detect another vehicle travelling or overtaking in the next lane behind. The system operates at speeds above 10km/h, and will illuminate the BSW warning light in the corresponding side mirror when a vehicle is in the detection zone. If driver activates the turn signal towards the corresponding hazard, the BSW lamp will blink and audible alert will sound twice.

KEY SPECIFICATIONS AND FEATURES

KEY	■	Standard
	□	Optional
	-	Not available

	2WD		4WD		
	GLX Double Cab Pick Up	GLX Double Cab Pick Up	GLX+ Double Cab Pick Up	GLS Double Cab Pick Up	GSR Double Cab Pick Up
	Auto	Auto	Auto	Auto	Auto
Engine	2.4L 4N16 Bi-Turbo Diesel		2.4L 4N16 Bi-Turbo Diesel		
Type	2.4		2.4		
Size (L)	2442		2442		
Displacement (cc)	86.0 x 105.1		86.0 x 105.1		
Bore x Stroke (mm)	150@3500		150@3500		
Maximum Power (kW@rpm)	470@1500-2750		470@1500-2750		
Maximum Torque (Nm@rpm)	Diesel		Diesel		
Fuel Type	■	■	■	■	■
Engine Auto Stop & Go	■	■	■	■	■
Fuel consumption (ADR 81/02per100km)*	75		7.7		
CO ₂ - g/km	197		203		
Fuel tank capacity (L)	75		75		
AdBlue tank capacity (L)	17		17		
Transmission	Auto		Auto		
Type	6		6		
Number of speeds	■	■	■	■	■
Manual shift mode	3.600	3.600	3.600	3.600	3.600
Gear ratio 1st	2.090	2.090	2.090	2.090	2.090
2nd	1.488	1.488	1.488	1.488	1.488
3rd	1.000	1.000	1.000	1.000	1.000
4th	0.687	0.687	0.687	0.687	0.687
5th	0.580	0.580	0.580	0.580	0.580
6th	3.732	3.732	3.732	3.732	3.732
Reverse	4.272	4.272	4.272	4.272	4.272
Rear axle ratio	-		1.000 / 2.566		
4WD transfer box - High / Low ratio	-	■	■	-	-
Easy Select 4WD	-	-	-	■	■
Super Select 4WD-II	-	-	-	■	■
Selectable off-road modes	-	-	-	■	■
Active Yaw Control (AYC)	-	-	-	■	■
Rear differential lock	-	-	■	■	■
Steering and Chassis	■		■		
Electric Power Steering (EPS)	■	■	■	■	■
Steering Gear Type Rack & Pinion	■	■	■	■	■
Front brakes	Ventilated disc 320 mm		Ventilated disc 320 mm		
Rear brakes	11.6" LT drum		11.6" LT drum		
Front suspension	High mounted double wishbone with coil spring & stabiliser bar		High mounted double wishbone with coil spring & stabiliser bar		
Rear suspension	Leaf spring (heavy duty)	Leaf spring (heavy duty)		Leaf spring (Standard)	
Underbody guard (heavy duty)	-	■	■		
Wheels and Tyres	Steel		Alloy		
Wheel type	17 x 75J		17 x 75J		
Wheel size (inches)	Highway Terrain		All Terrain		
Tyre type	265/65R17 112H		265/65R17 112H		265/60R18 110H
Tyre size	265/65R17 112H		265/65R17 112H		265/60R18 110H
Spare wheel type	Full size	Full size	Full size (alloy)	Full size (alloy)	Alloy (black finish)

*Australian Standard ADR 81/02. Figures to be used for comparison across vehicles. Driving conditions will affect actual results.

■	Standard
□	Optional
-	Not available

SAFETY, SECURITY AND DRIVER ASSISTANCE

	2WD		4WD		
	GLX Double Cab Pick Up	GLX Double Cab Pick Up	GLX+ Double Cab Pick Up	GLS Double Cab Pick Up	GSR Double Cab Pick Up
	Auto	Auto	Auto	Auto	Auto
Active Safety					
Forward Collision Mitigation (FCM) with Cyclist & Pedestrian detection	■	■	■	■	■
Forward Collision Mitigation (FCM) Junction assist	■	■	■	■	■
Rear Autonomous Emergency Braking (R-AEB)	■	■	■	■	■
Front Cross Traffic Alert (FCTA)^	□	□	□	□	□
Rear Cross Traffic Alert (RCTA)	■	■	■	■	■
Automatic post-collision braking	■	■	■	■	■
Emergency Lane Assist (ELA)	■	■	■	■	■
Lane Departure Prevention (LDP)	■	■	■	■	■
Lane Departure Warning (LDW)	■	■	■	■	■
Lane Change Assist (LCA)	■	■	■	■	■
Blind Spot Warning (BSW)	■	■	■	■	■
Driver Monitoring System (DMS)	■	■	■	■	■
Driver Attention Alert (DAA)	■	■	■	■	■
Intelligent Speed Limiter (ISL)	■	■	■	■	■
Tyre Pressure Monitoring System (TPMS)	■	■	■	■	■
Automatic High Beam (AHB)	■	■	■	■	■
Emergency Stop Signal function (ESS)	■	■	■	■	■
Emergency Brake Assist system (EBA)	■	■	■	■	■
Hill Start Assist (HSA)	■	■	■	■	■
Hill Descent Control (HDC)	-	-	-	■	■
Active Stability Control (ASC)	■	■	■	■	■
Trailer Stability Assist (TSA)	■	■	■	■	■
Active Traction Control (ATC)	■	■	■	■	■
Anti-lock Braking System (ABS)	■	■	■	■	■
Electronic Brakeforce Distribution (EBD)	■	■	■	■	■
Brake Override System (BOS)	■	■	■	■	■
Airbags					
Driver & front passenger SRS airbags	■	■	■	■	■
Driver & front passenger side SRS airbags	■	■	■	■	■
Curtain SRS airbags	■	■	■	■	■
Driver knee airbag	■	■	■	■	■
Centre airbag	■	■	■	■	■
Seat Belts					
Front seat belt pretensioners	■	■	■	■	■
Front seat belt force limiters	■	■	■	■	■
Child Safety					
ISO-Fix child seat anchorage	2	2	2	2	2
Child restraint top tether	2	2	2	2	2
Child proof rear door locks	■	■	■	■	■
Power window lock driver control - passenger	■	■	■	■	■
Driver Assistance					
Cruise control	■	■	■	■	■
Adaptive Cruise Control (ACC)	■	■	■	■	■
Traffic Sign Recognition (TSR)	■	■	■	■	■
Multi Information Display (inches)	7.0	7.0	7.0	7.0	7.0
Electrochromatic rear view mirror	-	-	-	■	■
Automatic dusk sensing headlights	■	■	■	■	■
Automatic rain sensing wipers	■	■	■	■	■
Speed sensitive intermittent windscreen wipers	■	■	■	■	■
Parking Assistance					
Multi Around Monitor (MAM)	■	■	■	■	■
Rear view camera	■	■	■	■	■
Front parking sensors	■	■	■	■	■
Rear parking sensors	■	■	■	■	■
Security					
Auto Door Lock By Speed Sensing	■	■	■	■	■
Encrypted engine immobiliser	■	■	■	■	■

^No Cost Option. Not compatible with Front Protection Bar (FPB)

KEY	■	Standard
	□	Optional
	-	Not available

		2WD		4WD		
		GLX Double Cab Pick Up	GLX Double Cab Pick Up	GLX+ Double Cab Pick Up	GLS Double Cab Pick Up	GSR Double Cab Pick Up
		Auto	Auto	Auto	Auto	Auto
AUDIO & MULTIMEDIA	Audio & Multimedia					
	Smartphone link Display Audio (SDA) with touch screen	■	■	■	■	■
	Touch screen size (inches)	9.0	9.0	9.0	9.0	9.0
	Android Auto	■	■	■	■	■
	Wireless Apple CarPlay	■	■	■	■	■
	Satellite navigation	■	■	■	■	■
	Speakers	4	4	4	6	6
	Bluetooth connectivity with Audio streaming	■	■	■	■	■
	Digital Audio Broadcast (DAB) radio	-	-	■	■	-
	AM/FM radio	■	■	■	■	■
USB input	2	2	2	2	2	
COMFORT & CONVENIENCE	Comfort & Convenience					
	Smart key	-	-	-	■	■
	One touch start system	-	-	-	■	■
	Keyless entry with central door locking	■	■	■	■	■
	Multifunction steering wheel controls	■	■	■	■	■
	Tilt & telescopic steering column	■	■	■	■	■
	Auto up/down driver control - driver side window	■	■	■	■	■
	Rear window demisters	■	■	■	■	■
	Accessory socket (12V)	■	■	■	■	■
	Smartphone wireless charger	-	-	-	■	■
Second row seat USB power supply	-	-	2	2	2	
AIR CONDITIONING	Air Conditioning					
	Automatic air conditioner (No of zones)	1	1	1	2	2
	Roof mounted air circulator	■	■	■	■	■
	Dust and pollen filter	■	■	■	■	■
EXTERIOR	Exterior					
	Door handles finish	Material black	Material black	Material black	Chrome	Black
	Privacy glass	-	-	■	■	■
	Roof rails	-	-	-	-	■
	Side steps	-	-	■	■	■
	Lights					
	Headlights low beam	Halogen	Halogen	Halogen	LED	LED
	Headlights high beam	Halogen	Halogen	Halogen	LED	LED
	Manual headlight levelling function	■	■	■	■	■
	Daytime Running Lights (DRL)	Halogen	Halogen	Halogen	LED	LED
	Fog lights (front)	-	-	■	■	■
	Door Mirros					
	Electric adjustment	■	■	■	■	■
	Electric fold control	-	-	-	■	■
	Heating function	-	-	-	■	■
	Integrated turn indicator	-	-	-	LED	LED
	Finish	Material black	Material black	Material black	Chrome	Black
	Rear Body					
	Tray tie-down points	4	4	4	4	4
	Rear step bumper	■	■	■	■	■
Front mud flaps	■	■	■	■	■	
Rear mud flaps	■	■	■	■	■	
INTERIOR	Styling					
	Leather bound steering wheel	-	-	-	■	■
	Leather bound gearshift	-	-	-	■	■
	Leather bound park brake	-	-	-	■	■
	Orange accent stitching	-	-	-	-	■
	Carpet floor covering	-	-	-	■	■
Vinyl floor covering	■	■	■	-	-	

■	Standard
□	Optional
-	Not available

	2WD	4WD			
	GLX Double Cab Pick Up	GLX Double Cab Pick Up	GLX+ Double Cab Pick Up	GLS Double Cab Pick Up	GSR Double Cab Pick Up
	Auto	Auto	Auto	Auto	Auto
Interior					
Seating					
Leather appointed seats	-	-	-	□	■
Fabric seat trim	■	■	■	-	-
Heated front seats	-	-	-	□	■
Driver's seat power adjustment	-	-	-	□	■
Driver's seat manual adjustment	■	■	■	■	-
Driver's seat power lumbar adjustment	■	■	■	■	■
2nd row centre armrest with cupholders	■	■	■	■	■
Storage					
Centre console with storage box and lid	■	■	■	■	■
Upper glove box - with lid	-	-	-	■	■
Upper glove box - open	■	■	■	-	-
Cup holders - dash mounted	-	-	-	-	2
Cup holders - other	4	4	4	4	4
Bottle holders	4	4	4	4	4
Sunglasses storage	■	■	■	■	■
Door pockets - front	■	■	■	■	■
Seat back pocket - driver and passenger	■	■	■	■	■
Dimensions and Weight					
Exterior Dimensions					
Overall length (mm)	5320	5320	5320	5320	5320
Overall width (mm)	1865	1865	1865	1865	1930
Overall height (mm)	1785	1795	1795	1795	1795
Wheelbase (mm)	3130	3130	3130	3130	3130
Turning circle, kerb to kerb (m)	12.7	12.7	12.7	12.7	12.7
Approach angle (degrees)	30.4	30.4	30.4	30.4	30.4
Departure angle (degrees)	22.8	22.8	22.8	22.8	22.8
Ramp breakover angle (degrees)	23.6	23.4	23.4	23.4	23.4
Ground clearance (mm)	228	228	228	228	228
Interior Dimensions					
Front head room (mm)	1000			1000	
Front leg room (mm)	1059			1059	
Front shoulder room (mm)	1479			1479	
2nd row head room (mm)	972			972	
2nd row leg room (mm)	857			857	
2nd row shoulder room (mm)	1445			1445	
Weight and Capacities					
Kerb mass (kg)	2000	2117	2105	2125	2170
Gross vehicle mass (GVM) - (kg)	3070		3200		3200
Gross combination mass (GCM) - (kg)	6210		6250		6250
Maximum payload (kg)	1070	1083	1095	1075	1030
Maximum front axle load (kg)	1500		1580		1580
Maximum rear axle load (kg)	1980		2040		2040
Towing capacity - braked (kg)	3500		3500		3500
Towing capacity - unbraked (kg)	750		750		750
Towing capacity - maximum towball load (kg)	350		350		350
Cargo					
Cargo body interior length (mm)	1555	1555	1555	1555	1555
Cargo body interior width (mm)	1545	1545	1545	1545	1545
Cargo body interior height (mm)	525	525	525	525	525
Cargo body floor height from ground (mm)	820	820	820	820	820
Width between wheel arches (mm)	1135	1135	1135	1135	1135
Accessory					
Standard					
Black Sailplane	-	-	-	-	■
Tub Liner	-	-	-	■	■
Carpet Mats	-	-	-	-	■

EXTERIORS

DOUBLE CAB **GLX**

[2WD] 6 AT [4WD] 6 AT



DOUBLE CAB **GLX+**

[4WD] 6 AT



DOUBLE CAB **GLS**

[4WD] 6 AT



DOUBLE CAB **GSR**

[4WD] 6 AT



INTERIORS



Black Fabric



Black Fabric with Silver Stitching



Black Fabric with Silver Stitching. Leather Appointed* with Silver Stitching (Optional)



Black Leather Appointed* with Orange Stitching

*Leather appointed seats are a combination of genuine and artificial leather, and are not wholly leather.

DOUBLE CAB



2WD GLX DOUBLE CAB – PICK UP

FEATURES:

- 2.4L Intercooled Bi-Turbo Diesel
- 6 Speed Automatic Transmission With Manual Shift Mode
- Transmission Shift Lock with Key Interlock
- 17" Steel Wheels
- Electric Power Steering
- Heavy Duty Suspension
- Auto High Beam System
- Rear Window Demisters
- Tilt And Telescopic Steering Column
- Power Door Mirrors – Black
- Power Windows
- 3 Spoke Steering Wheel
- Steering Wheel Audio Controls
- Steering Wheel Phone Controls
- Seating Capacity – 5
- Cruise Control
- Central Door Locking With Keyless Entry
- 7-inch Multi-Information Display
- Smartphone link Display Audio with 9-inch Touch Screen
- Satellite Navigation System
- AM/FM Radio
- USB Input x 2 (1 x Type A, 1 x Type C)
- Bluetooth Phone Connectivity & Audio Streaming With Voice Control
- 4 Speakers
- USB Power Socket 1 x Type A & 1 x Type C
- 12V Accessory Socket – Console
- 8 SRS Airbags
- Automatic Air Conditioning
- Vinyl Floor Covering
- Fabric Seat Trim
- Mud Flaps – Front & Rear
- Tyre Pressure Monitoring System (TPMS)
- Rear View Camera
- Front & Rear Parking Sensors
- Accessory Power Socket
- Door Pockets
- Cup Holders x 4
- Bottle Holders x 4
- Rear Body Guard
- Driver And Passenger Assist Grips
- Roof Mounted Air Circulator
- Wireless Apple CarPlay
- Android Auto
- Driver Seat Power Lumbar Adjustment

MITEC MITSUBISHI INTUITIVE TECHNOLOGY

- Adaptive Cruise Control (ACC)
- Active Stability Control (ASC)
- Traction Control System (TCS)
- Hill Start Assist (HSA)
- Trailer Stability Assist (TSA)
- Emergency Stop Signal System (ESS)
- Forward Collision Mitigation (FCM) With Pedestrian, Cyclist Sensing & Junction Assist
- Rear Cross Traffic Alert (RCTA)
- Lane Departure Warning (LDW)
- Lane Change Alert (LCA)
- Emergency Lane Keeping (ELK)
- Blind Spot Warning (BSW)
- Blind Spot Intervention
- Traffic Sign Recognition (TSR)
- Driver Attention Alert (DAA)
- Driver Monitor System (DMS)
- Multi Around View Monitor
- Rear Automatic Emergency Braking
- Automatic Post Collision Braking
- Intelligent Speed Limiter



4WD GLX DOUBLE CAB – PICK UP

INCLUDES ALL 2WD GLX DOUBLE CAB FEATURES PLUS:

- Easy Select 4WD
- Two Speed Transfer
- All Terrain Tyres



4WD GLX+ DOUBLE CAB – PICK UP

INCLUDES ALL 4WD GLX DOUBLE CAB – PICK UP FEATURES PLUS:

- Rear Differential Lock
- 17" Alloy Wheels
- Side Steps
- Front Fog Lamps
- DAB
- 2nd Row USB Power Socket x 2 (1 x Type A, 1 x Type C)
- Privacy Glass
- Seat Silver Accent Stitching



4WD GLS DOUBLE CAB – PICK UP

INCLUDES ALL 4WD GLX+ DOUBLE CAB – PICK UP FEATURES PLUS:

- Super Select 4WD-II
- Terrain Control – 7 Modes
- Hill Descent Control (HDC)
- 18" Alloy Wheels
- Highway Terrain Tyres
- Gloss Black Grille
- LED Headlights
- LED Daytime Running Lights (DRL)
- Chrome Door Handles
- Fabric Seat Trim (Optional Leather Appointed†)
- Power Drivers Seat (Optional)
- Heated Front Seats (Optional)
- Door Mirrors With Power Fold Control and Integrated Turn-Indicator
- Smart Key
- One Touch Start System
- Door Trim Fabric Inserts (Optional Leather Appointed†)
- Interior Trim With Silver Accent
- Climate Control Dual Zone Air Conditioning
- 6 Speakers
- Smartphone Wireless Charger
- Electrochromic Rear View Mirror

GENUINE ACCESSORIES FITTED AT FACTORY#

- Tub Liner



4WD GSR DOUBLE CAB – PICK UP

INCLUDES ALL 4WD GLS DOUBLE CAB – PICK UP FEATURES PLUS:

- 18" Black Alloy Wheels
- Black Door Handles
- Black Roof Rail
- Black Rear Bumper
- Body Colour Grille
- Leather Appointed† Seat Trim With Orange Accent Stitching
- Heated Front Seats
- Driver's Seat Power Adjustment
- Leather Appointed† Door Trims With Orange Accent Stitching
- Interior Trim With Dark Titanium Accents
- Cup Holders – Dash Mounted

GENUINE ACCESSORIES FITTED AT FACTORY#

- Black Sailplane
- Tub Liner
- Carpet Mats

#Genuine Accessories fitted at factory are MITSUBISHI MOTORS Genuine Accessories. These accessories are not covered by the vehicle warranty, however they are covered by Mitsubishi's Genuine Accessories warranty and are subject to the terms and conditions of this warranty. For warranty conditions regarding Genuine Accessories, please refer to MITSUBISHI MOTORS website or see your local dealer.

EXTERIOR DIMENSIONS (MM)

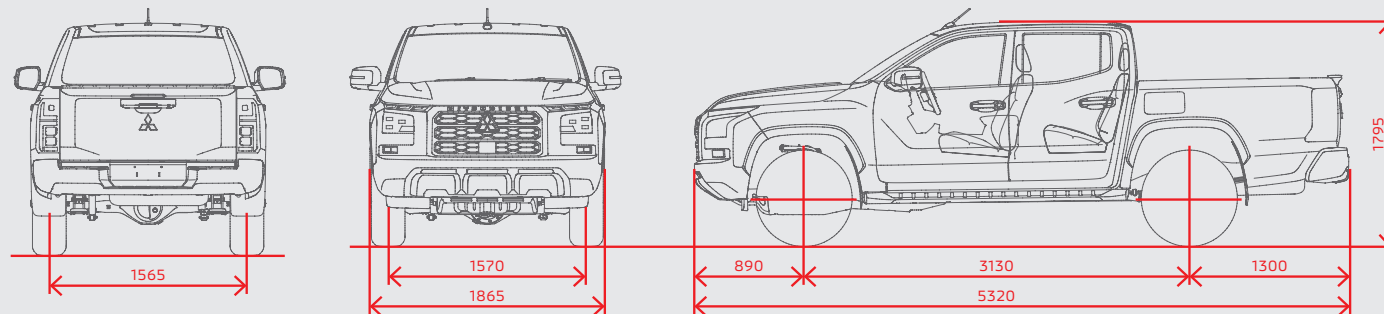

†Leather appointed seats are a combination of genuine and artificial leather, and are not wholly leather.

STRONGER. STURDIER. TOUGHER.



Why Genuine Accessories?

Each and every one goes through an extensive program of design, development and stringent testing to ensure they meet all applicable government standards as well as Mitsubishi's own rigorous engineering specifications and performance targets.

MITSUBISHI
DIAMOND
ADVANTAGE
GENUINE ACCESSORIES

**NOT GENUINE?
DON'T RISK IT.**

EXTERIOR & INTERIOR



Front Protection Bar (Steel) - Winch compatible



Front Protection Bar (Alloy) - Winch compatible



Winch Cradle - Closed



Winch Cradle - Open



Nudge Bar (Black)



Nudge Bar (Polished)



Driving Lamps - including Harness - Suits FPB or Nudge Bar



Headlight Protectors (suits models with LED headlamps only)



Bonnet Protector (Clear)



Bonnet Protector (Tinted)



Bonnet Protector (Matte)



Weathershields



Grille Emblem (Chrome)



Grille Emblem (Black)



Under Ride Protection



Fender Flares - not compatible with Front Protection Bar



Rear Protection Bar - requires fitment of genuine Tow Bar



Side Protection Bar



Sailplane (Black)



Sports Bar (Black)



Sports Bar (Polished)



Rubber Floor Mats with High Edge



Rubber Floor Mats with Low Edge



Carpet Floor Mats



Carpet Floor Mats with Triton logo

For availability of accessories, please speak with your Mitsubishi Dealership. Some accessories may be dependent on, or incompatible with, other accessories or vehicle systems, speak with your Mitsubishi Dealership. MMAL warrants that Genuine Accessories will be free from defects in material under conditions of normal use and service within Australia. When Genuine Accessories are fitted by a Mitsubishi Dealer prior to the owner/operator taking delivery of the vehicle, Genuine Accessories are covered by the Standard New Car Warranty of 5 years or 100,000 km Warranty. Or, if the vehicle is eligible for the Extended New Car Warranty, Genuine Accessories will be covered up to a maximum of 10 years or 200,000km (whichever occurs first), except where items are expressly excluded or for which a separate warranty applies. When Genuine Accessories are fitted by a Mitsubishi Dealer after the owner/operator has taken delivery on the new vehicle, Genuine Accessories are warranted for whichever is the greater of the following. 12 months or 20,000km (whichever occurs first); or the balance of the Standard New Car Warranty of 5 years or 100,000km Warranty; or, if the vehicle is eligible for the Extended New Car Warranty, Genuine Accessories will be covered up to a maximum of 10 years or 200,000km (whichever occurs first), except where items are expressly excluded or for which a separate warranty applies. If not fitted by a Mitsubishi Dealer, Genuine Accessories are covered for 12 months or 20,000km (whichever occurs first) For warranty conditions regarding Genuine Accessories, please refer to Mitsubishi Motors website www.mitsubishi-motors.com.au/owners/accessories or speak with your Mitsubishi Dealership. *If the Front Cross Traffic Alert (FCTA) system is enabled, the fitment of a Genuine Front Protection Bar to the vehicle will interfere with the operation of the vehicle's radar sensors. The FCTA system will need to be disabled if a Genuine Front Protection Bar is fitted to the vehicle. Pictures shown are for illustration purpose and may not be product specific.

CARGO & TOWING



Canopy Lift/Lift Windows (Body Colour) - Closed



Canopy Lift/Lift Windows (Body Colour) - Open



Two Tone Canopy Lift/Lift Windows (Body Colour/Jet Black) - Closed



Two Tone Canopy Lift/Lift Windows (Body Colour/Jet Black) - Open



Canopy Sliding Window - Left or Right Hand Side



Roof Rack Cross Bars - Double Cab with Roof Rails



Soft Tonneau Cover



Soft Tonneau Cover - with Sports Bar



Hard Tonneau Cover (Body Colour) - Closed



Hard Tonneau Cover (Body Colour) - Open



Aluminium Hard Tonneau Cover (Black) - Closed



Aluminium Hard Tonneau Cover (Black) - Open



Electric Roll Top Tonneau Cover



Electric Roll Top Tonneau - with Sailplane - Closed



Electric Roll Top Tonneau - with Sailplane - Open



Dust & Water Defence Kit



Rubber Tub Mat



Under Rail Tub Liner



Cargo Tie Down



Tow Bar, Tow Bar Harness & Tow Ball



Electric Trailer Brake Kit

Mitsubishi Genuine Accessories have been designed, developed and tested to comply with rigorous standards of quality and performance. Non-Genuine accessories have not been designed, developed, tested or approved as MMAL Genuine, so they will not be made available, supported, guaranteed or warranted by MMAL in any way. MMAL does not warrant that Non-Genuine will be compatible with Mitsubishi's Australian spec vehicles, including safety systems, or able to be installed or used on vehicles without affecting vehicle performance, functionality, or structural integrity.



COLOUR



White[^]



Blade Silver[^] (M)



Graphite Grey (M)



Red^{^#}



Impulse Blue^{^#} (M)



Black Mica[#] (P)



White Diamond^{**} (X)



Yamabuki Orange^{*} (X)

- (X) Prestige
- (M) Metallic
- (P) Pearlescent

[^]Not available on GSR
[#]Not available on GLX
^{*}Not available on GLX+
⁺Available on GSR only

UPHOLSTERY

 **BOOK A TEST DRIVE**

 **BUILD AND PRICE**

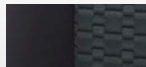

GLX Black Fabric

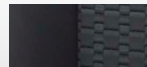

GLX+, GLS Black Fabric Silver Stitching

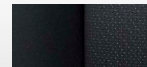

GLS (Optional) Black Leather Appointed* with Silver Stitching.
 GSR Black Leather Appointed* with Orange Stitching

AUSTRALIA'S FIRST

10
YEARS
 NEW CAR WARRANTY

10
YEARS
 CAPPED PRICE SERVICING

MITSUBISHI
DIAMOND
ADVANTAGE

WHEN ALL SCHEDULED SERVICES ARE COMPLETED
 AT A MITSUBISHI DEALERSHIP

All Mitsubishi Motors vehicles come with the Mitsubishi Diamond Advantage[#] – 10 Years Warranty* and 10 Years Capped Price Servicing[^] and Roadside Assistance so that no matter where the road takes you, we will be there with you. Ask your Dealer or visit mitsubishi-motors.com.au to find out more.

[^]Leather appointed seats are a combination of genuine and artificial leather, and are not wholly leather. [#]Conditions apply. Excludes Government, Rental and National Business customers. See Mitsubishi-motors.com.au for further details. *10 Year/200,000km New Car Warranty (whichever occurs first and when all scheduled services are completed at a Mitsubishi Dealership). [^]10 Year/150,000km Capped Price Servicing (whichever occurs first). Includes the first 10 regular services (at 15,000km/12 month scheduled intervals). Some items excluded or subject to separate warranty. Any non-regular service/repair items are at an additional cost. Servicing must be completed by a Mitsubishi Dealer within 7500kms or 6 months of the service due date. Valid from date of vehicle registration. Always consult your authorised Mitsubishi Dealer for the latest details, options, availability and conditions on New Vehicle warranty. All product illustration and specifications referred to herein are believed to be correct at the time of publication approval. Subject to any applicable Federal, State or Territory Laws or ordinances, which may apply from time to time. Mitsubishi Motors Australia Limited reserves the right, without notice, or obligation, to discontinue or make changes to designs, specifications, colours and material of the options and products referred herein at any time without incurring any liability to any purchase thereof. Mitsubishi Motors Australia Limited. ABN 53 007 870 395 © Mitsubishi Motors Australia Limited. ABN 53 007 870 395.